



एन सी ई आर टी
NCERT

NCERT

National Council Of Educational Research
And Training

NCERT Solutions for 6th Class Maths: Chapter 13- Symmetry



IndCareer
Schools



indCareer



indCareer



indCareer

NCERT Solutions for 6th Class Maths: Chapter 13-Symmetry

Class 6: Maths Chapter 13 solutions. Complete Class 6 Maths Chapter 13 Notes.

NCERT Solutions for 6th Class Maths: Chapter 13- Symmetry

NCERT 6th Maths Chapter 13, class 6 Maths Chapter 13 solutions

Exercise 13.1

1. List any four symmetrical objects from your home or school.

Answer

<https://www.indcareer.com/schools/ncert-solutions-for-6th-class-maths-chapter-13-symmetry/>

Notebook, Blackboard, Glass, Inkpot.

2. For the given figure, which one is the mirror line, l_1 or l_2 ?

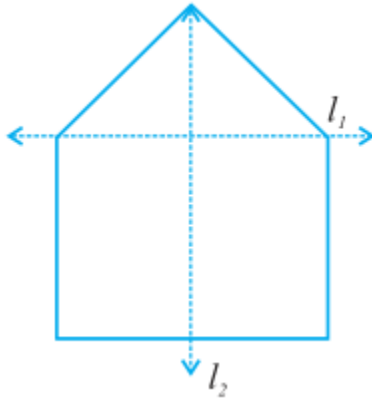

Answer

l_2 is the mirror line as both sides of the lines are symmetric.

3. Identify the shapes given below. Check whether they are symmetric or not. Draw the line of symmetry as well.

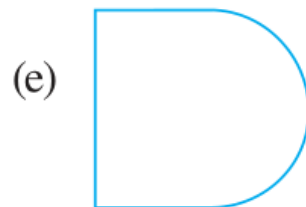
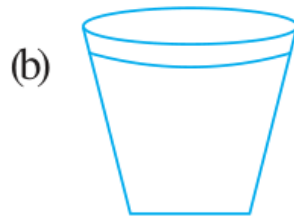

Answer

(a) Symmetric

<https://www.indcareer.com/schools/ncert-solutions-for-6th-class-maths-chapter-13-symmetry/>

(b) Symmetric

(c) Not Symmetric

(d) Symmetric

(e) Symmetric

(f) Symmetric

4. Copy the following on a squared paper. A square paper is what you would have used in your arithmetic notebook in earlier classes. Then complete them such that the dotted line is the line of symmetry.

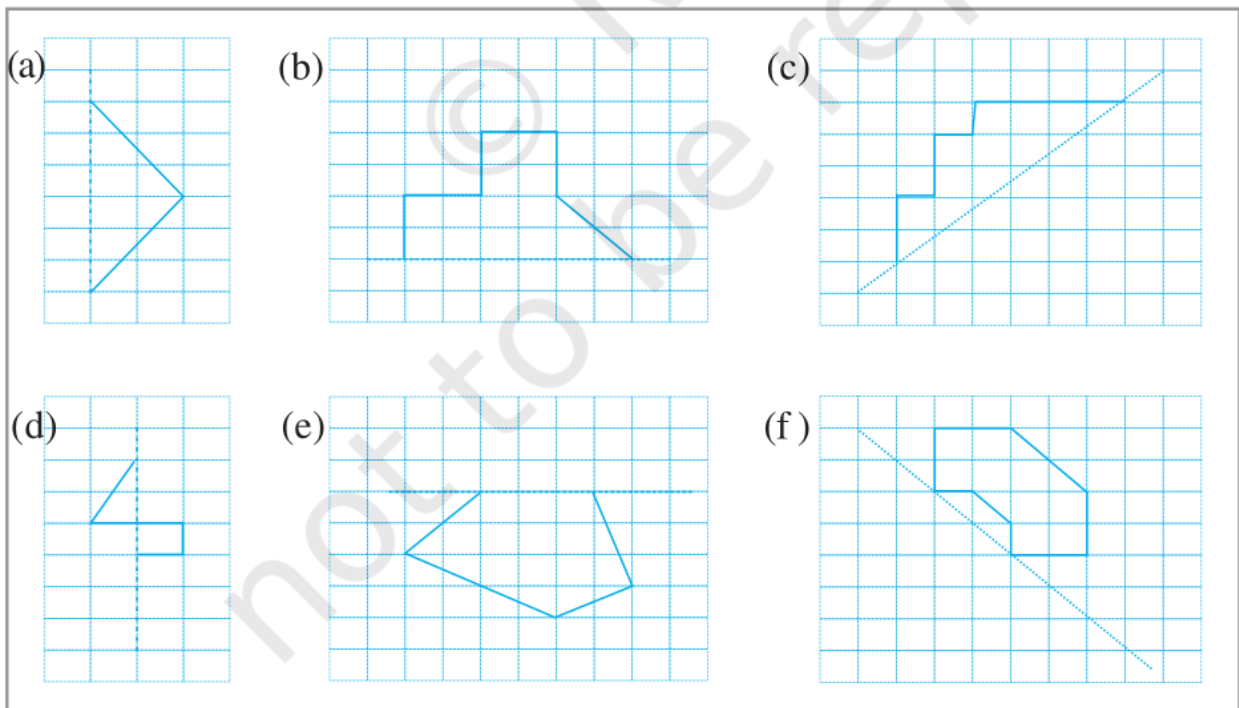

Answer

<https://www.indcareer.com/schools/ncert-solutions-for-6th-class-maths-chapter-13-symmetry/>

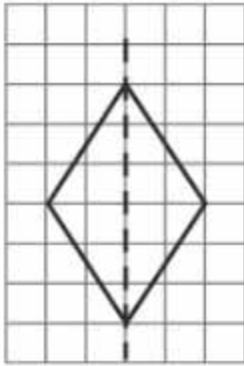

(a)

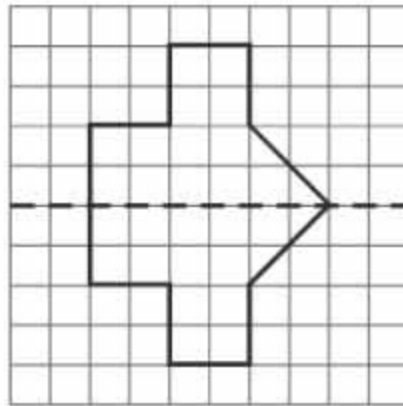

(b)

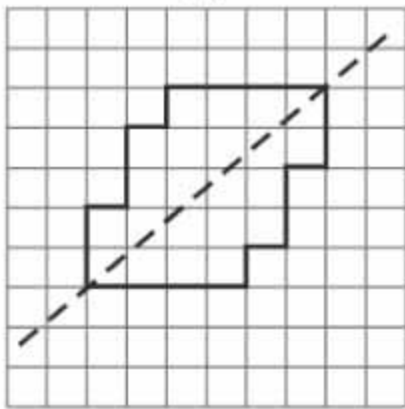

(c)

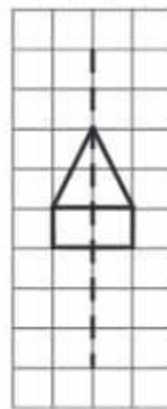

(d)

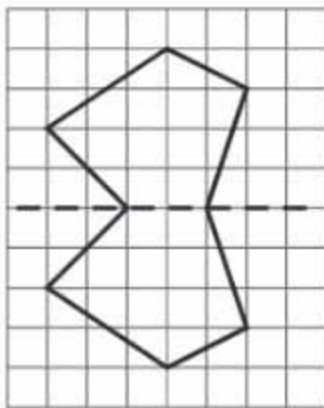

(e)

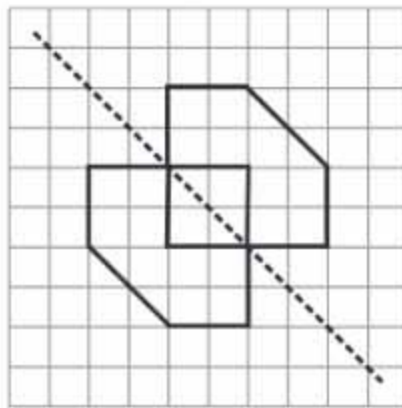

(f)

5. In the figure, l is the line of symmetry.

<https://www.indcareer.com/schools/ncert-solutions-for-6th-class-maths-chapter-13-symmetry/>

Complete the diagram to make it symmetric.

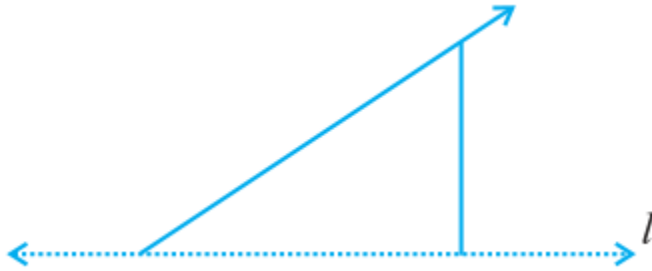

Answer

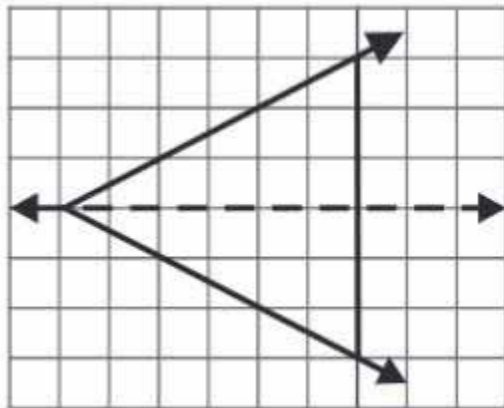

6. In the figure, l is the line of symmetry. Draw the image of the triangle and complete the diagram, so that it becomes symmetric.

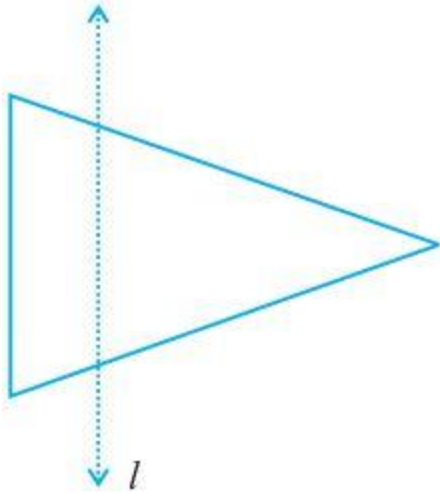

Answer

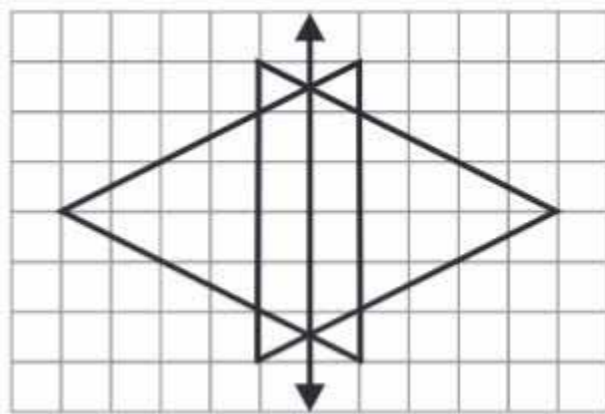

NCERT 6th Maths Chapter 13, class 6 Maths Chapter 13 solutions

Exercise 13.2

1. Find the number of lines of symmetry for each of the following shapes:

<https://www.indcareer.com/schools/ncert-solutions-for-6th-class-maths-chapter-13-symmetry/>

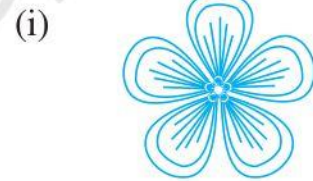
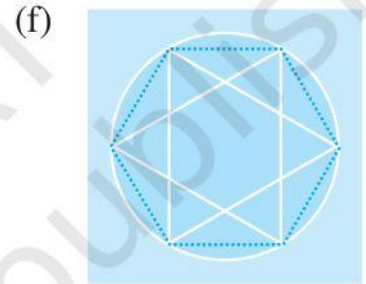
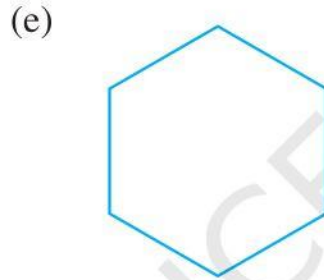
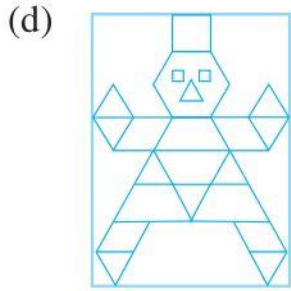
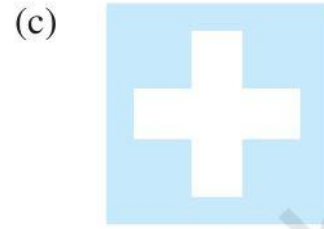
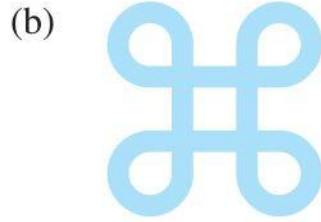
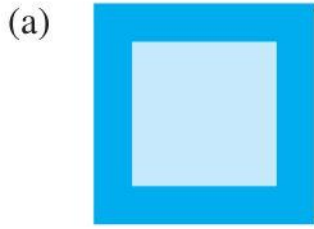

Answer

(a) 4

(b) 4

(c) 4

(d) 1

(e) 6

(f) 4

(g) 0

(h) 0

(i) 5

<https://www.indcareer.com/schools/ncert-solutions-for-6th-class-maths-chapter-13-symmetry/>

2. Copy the triangle in each of the following figures on squared paper. In each case, draw the line(s) of symmetry, if any and identify the type of triangle. (Some of you may like to trace the figures and try paper-folding first!)

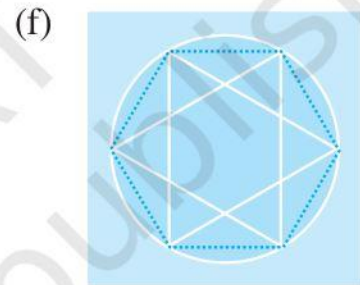
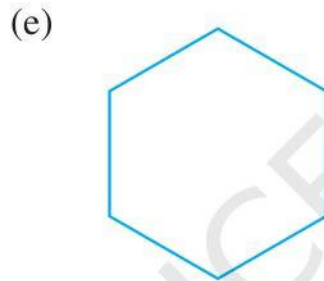
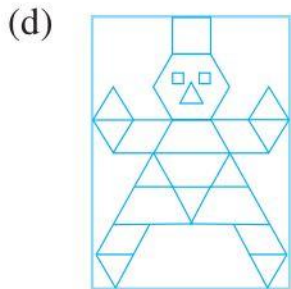
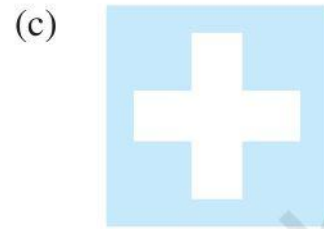
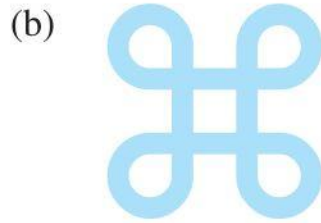
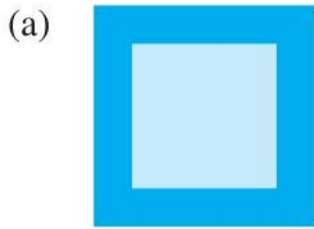

Answer

(a) l_1 is the line of symmetry.

(b) l_1 is the line of symmetry.

(c) l_1 is the line of symmetry.

(d) No line of symmetry.

3. Complete the following table.

<https://www.indcareer.com/schools/ncert-solutions-for-6th-class-maths-chapter-13-symmetry/>

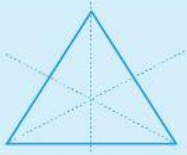
Shape	Rough figure	Number of lines of symmetry
Equilateral triangle		3
Square		
Rectangle		
Isosceles triangle		
Rhombus		
Circle		

Answer

<https://www.indcareer.com/schools/ncert-solutions-for-6th-class-maths-chapter-13-symmetry/>

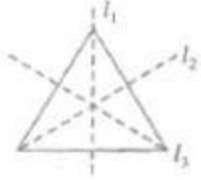
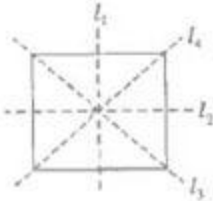
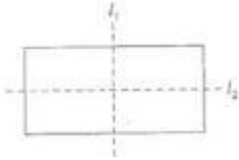
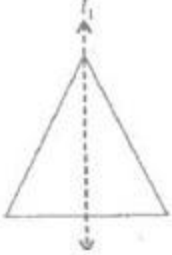
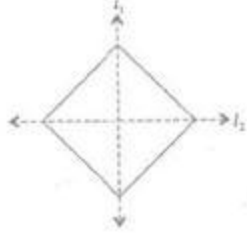
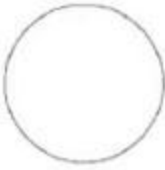
Shape	Rough figure	No. of lines of symmetry
Equilateral triangle		3
Square		4
Rectangle		2
Isosceles triangle		1
Rhombus		2
Circle		Infinite

<https://www.indcareer.com/schools/ncert-solutions-for-6th-class-maths-chapter-13-symmetry/>

4. Can you draw a triangle which has

- (a) exactly one line of symmetry?
- (b) exactly two lines of symmetry?
- (c) exactly three lines of symmetry?
- (d) no lines of symmetry?

Sketch a rough figure in each case.

Answer

- (a) Yes, Isosceles triangle

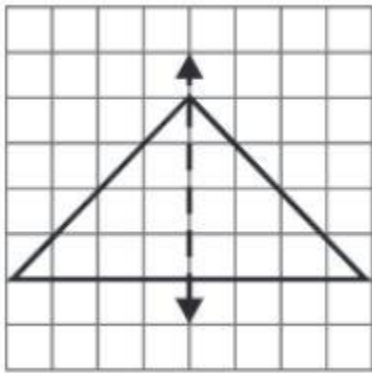

- (b) No such triangle cannot be formed.

- (c) Yes, Equilateral triangle.

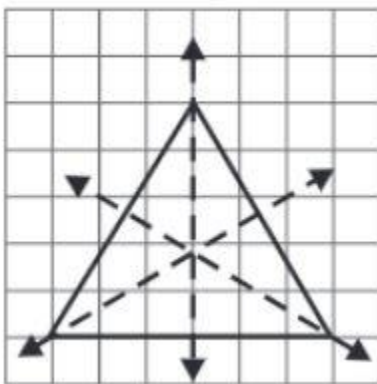

<https://www.indcareer.com/schools/ncert-solutions-for-6th-class-maths-chapter-13-symmetry/>

(d) Yes, Scalene triangle

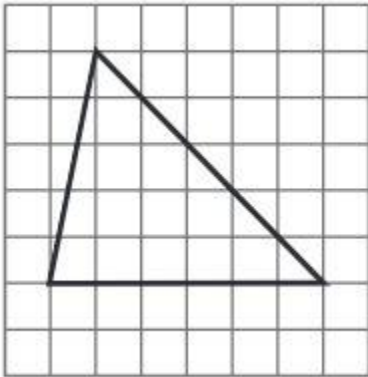

5. On a squared paper, sketch the following:

(a) A triangle with a horizontal line of symmetry but no vertical line of symmetry.

(b) A quadrilateral with both horizontal and vertical lines of symmetry.

(c) A quadrilateral with a horizontal line of symmetry but no vertical line of symmetry.

(d) A hexagon with exactly two lines of symmetry.

(e) A hexagon with six lines of symmetry.

(Hint: It will be helpful if you first draw the lines of symmetry and then complete the figures.)

Answer

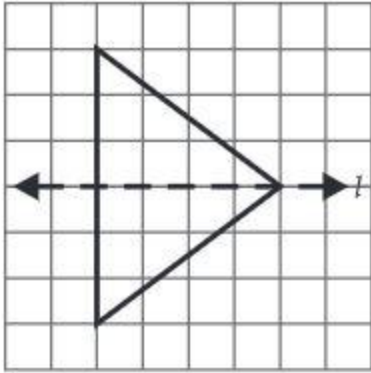

(a)

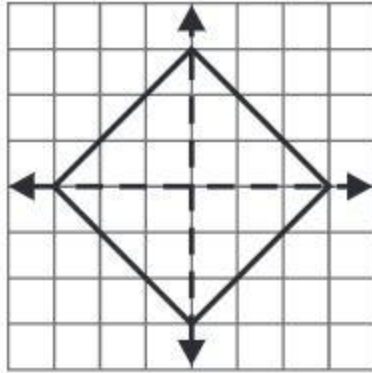

(b)

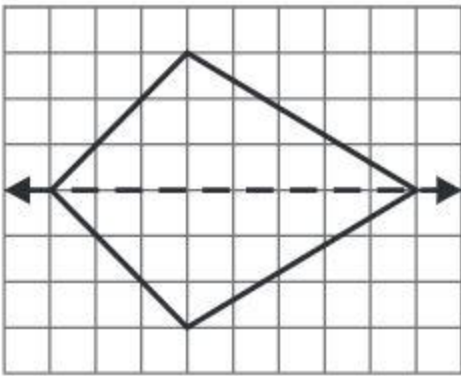

(c)

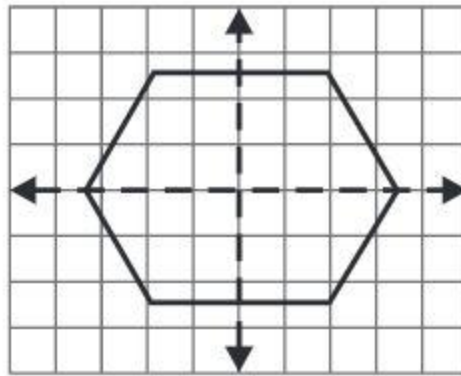

(d)

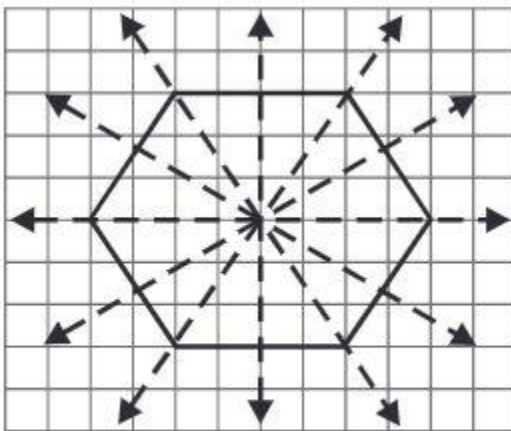

(e)

6. Trace each figure and draw the lines of symmetry, if any:

<https://www.indcareer.com/schools/ncert-solutions-for-6th-class-maths-chapter-13-symmetry/>

(a)

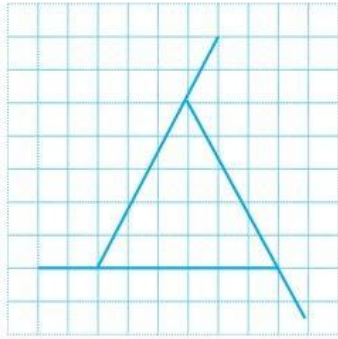

(b)

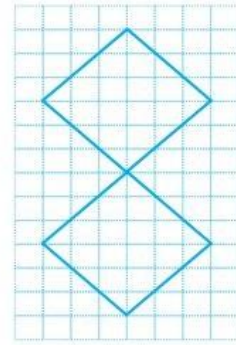

(c)

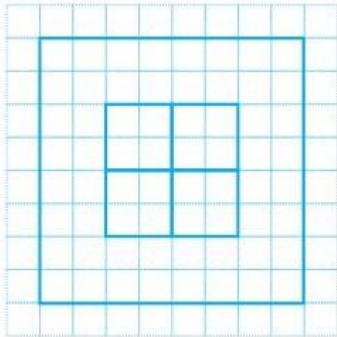

(d)

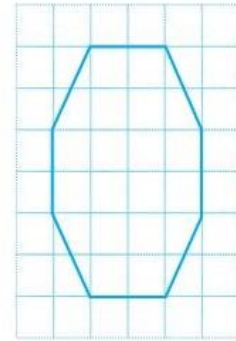

(e)

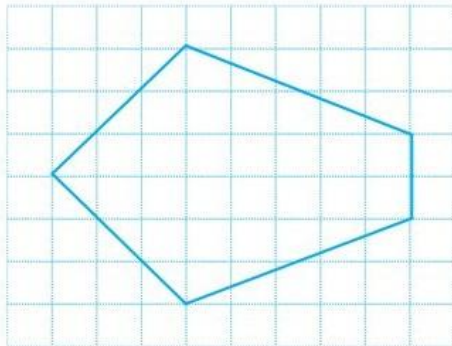

(f)

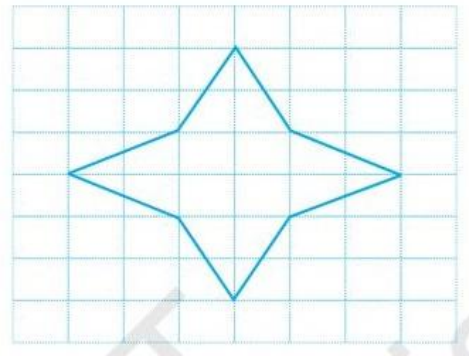

Answer

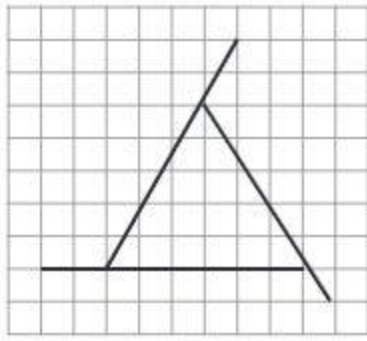

(a)

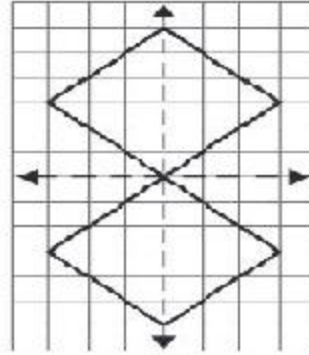

(b)

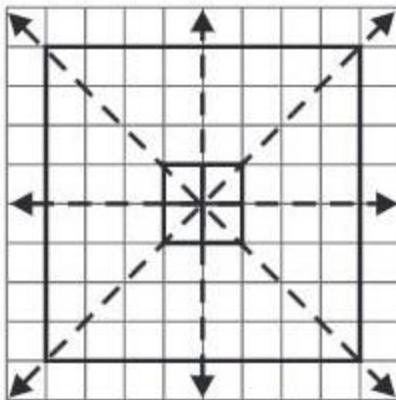

(c)

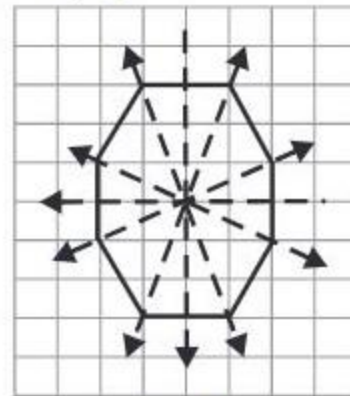

(d)

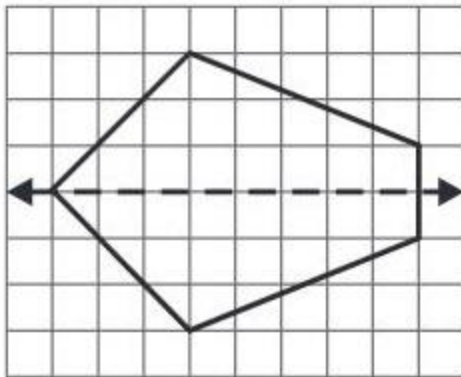

(e)

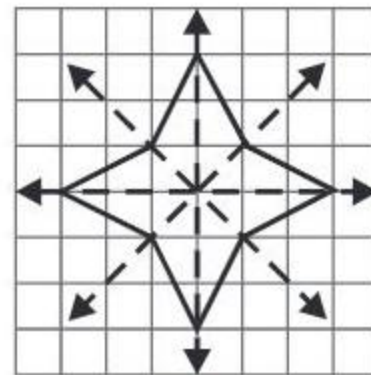

(f)

7. Consider the letters of English alphabet, A to Z. List among them the letters which have

<https://www.indcareer.com/schools/ncert-solutions-for-6th-class-maths-chapter-13-symmetry/>

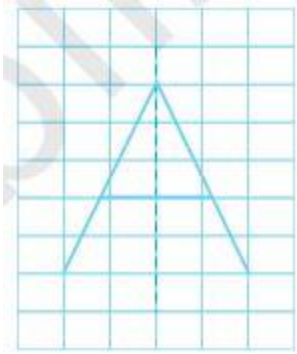

(a) vertical lines of symmetry (like A)

(b) horizontal lines of symmetry (like B)

(c) no lines of symmetry (like Q)

Answer

(a) vertical lines: A, H, I, M, O, T, U, V, W, X, Y

(b) horizontal lines: B, C, D, E, H, I, K, O, X

(c) no line of symmetry: F, G, J, N, P, Q, R, S, Z

8. Given here are figures of a few folded sheets and designs drawn about the fold. In each case, draw a rough diagram of the complete figure that would be seen when the design is cut off.

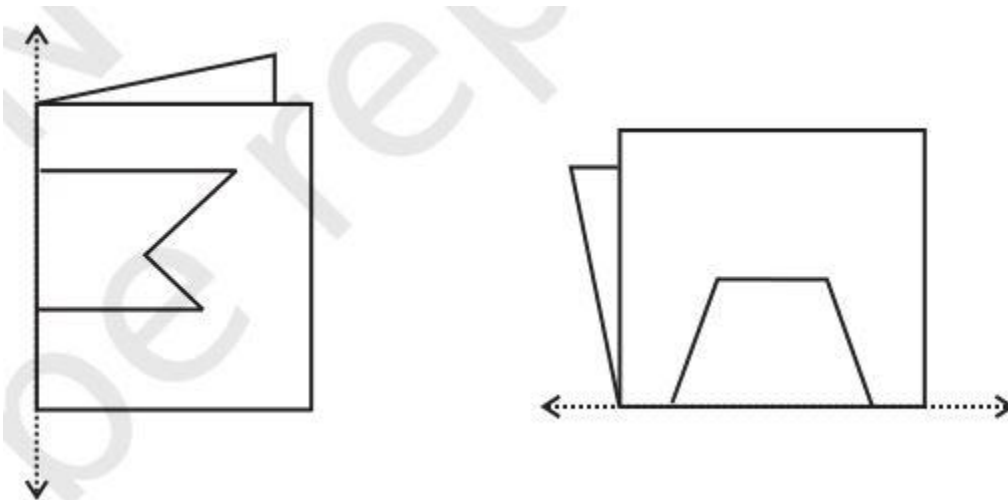

<https://www.indcareer.com/schools/ncert-solutions-for-6th-class-maths-chapter-13-symmetry/>

Answer

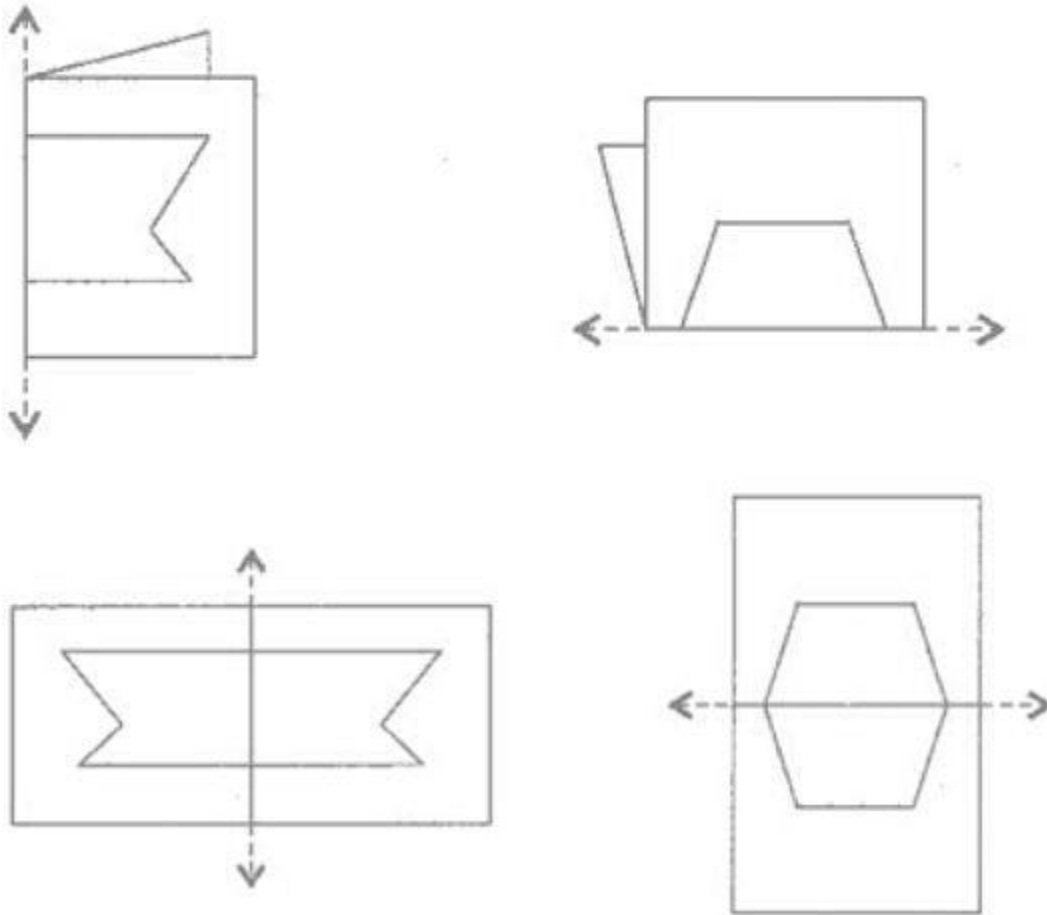

NCERT 6th Maths Chapter 13, class 6 Maths Chapter 13 solutions

Exercise 13.3

1. Find the number of lines of symmetry in each of the following shapes. How will you check your answers?

<https://www.indcareer.com/schools/ncert-solutions-for-6th-class-maths-chapter-13-symmetry/>

(a)



(b)



(c)



(d)

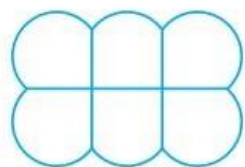

(e)

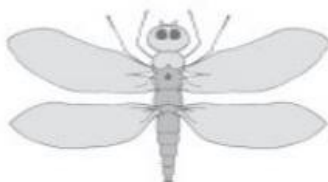

(f)

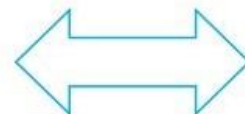

Answer

(a) four

(b) one

(c) two

(d) two

(e) one

(f) two

2. Copy the following drawing on squared paper. Complete each one of them such that the resulting figure has two dotted lines as two lines of symmetry. How did you go about completing the picture?

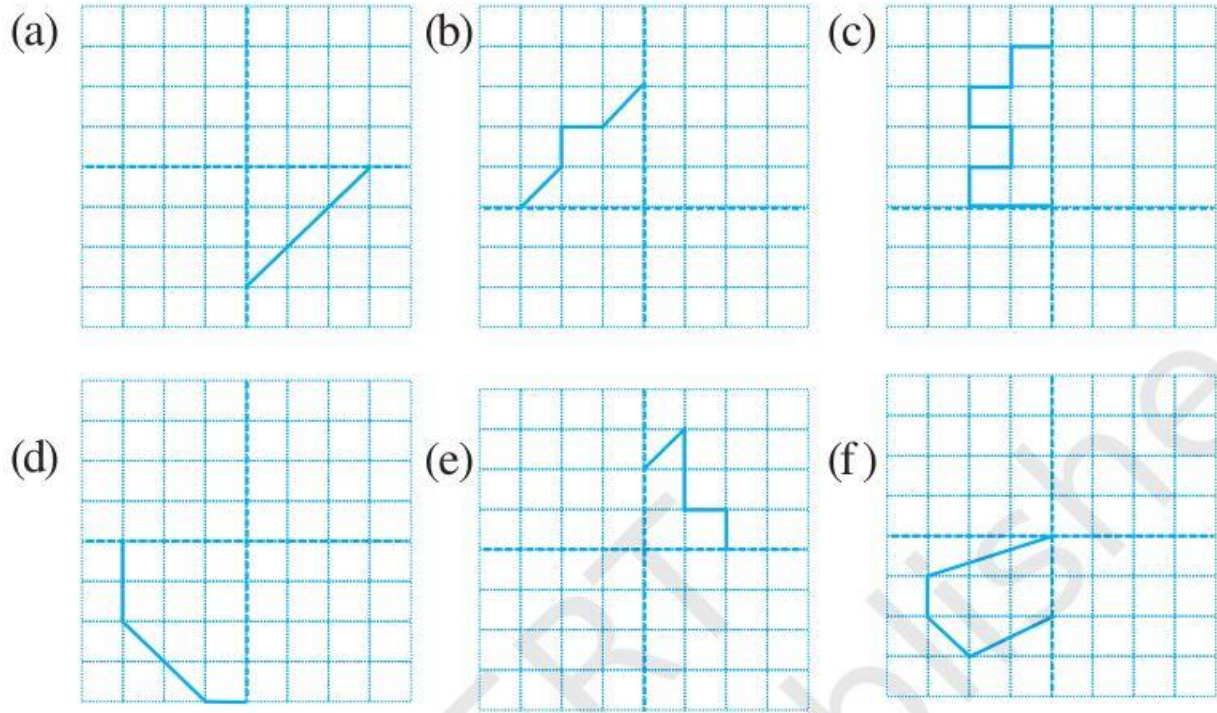

Answer

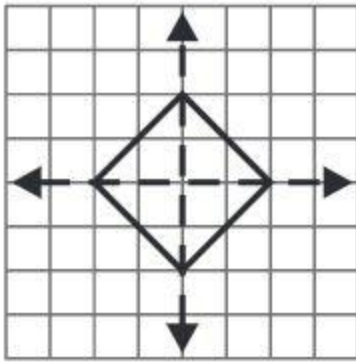

(a)

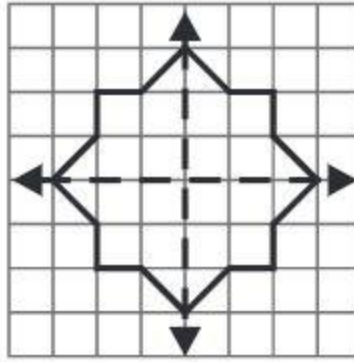

(b)

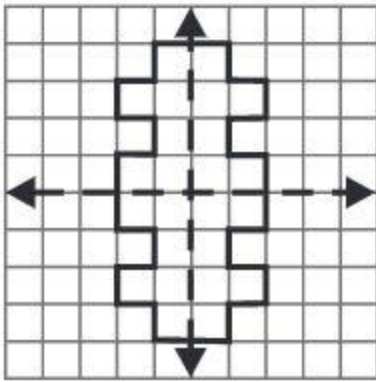

(c)

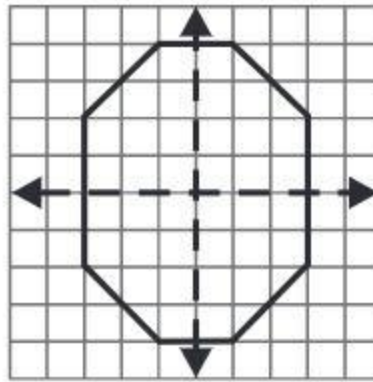

(d)

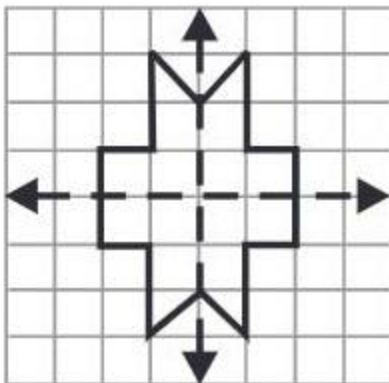

(e)

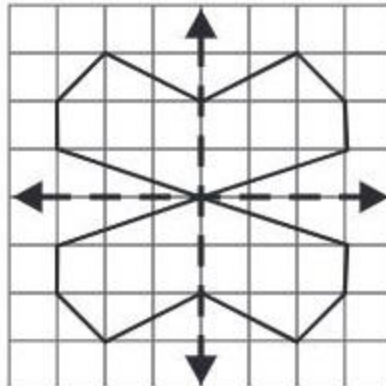

(f)

3. In each figure below, a letter of alphabet is shown along with a vertical line. Take the mirror image of the letter in the given line. Find which letters look the

<https://www.indcareer.com/schools/ncert-solutions-for-6th-class-maths-chapter-13-symmetry/>

same after reflection (i.e., which letters look the same in the image) and which do not. Can you guess why?

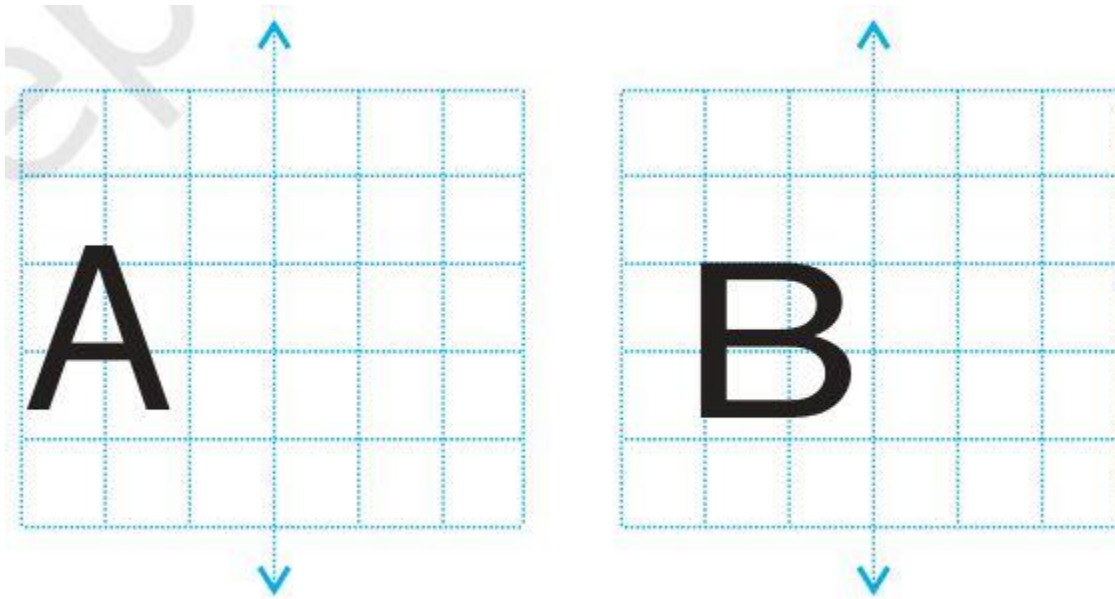

Try for O E M N P H L T S V X

Answer

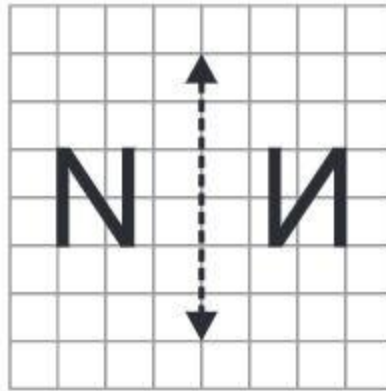
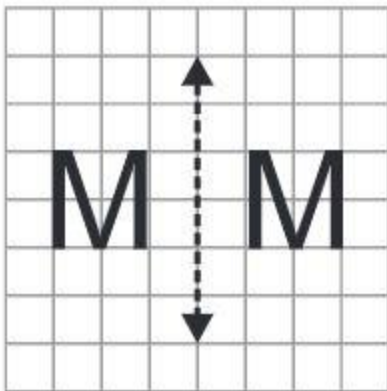
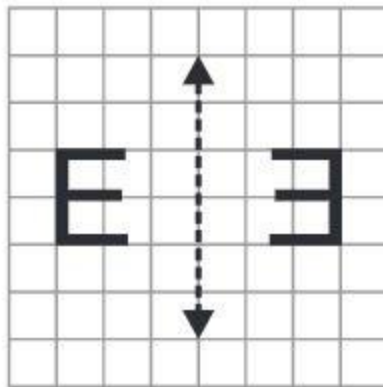
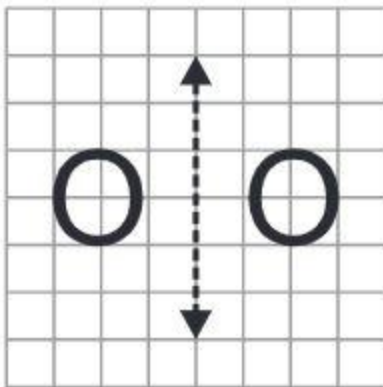
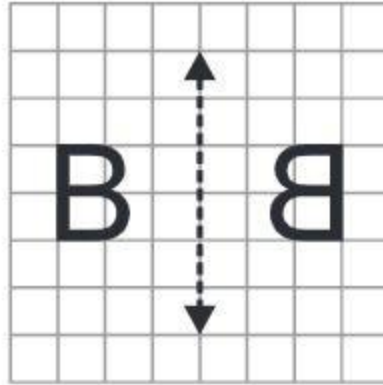
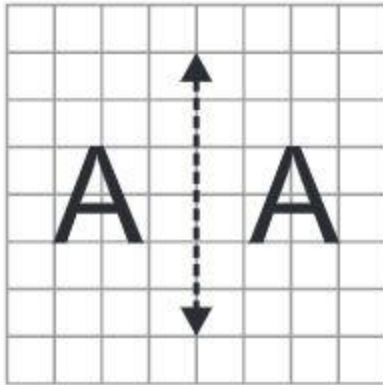

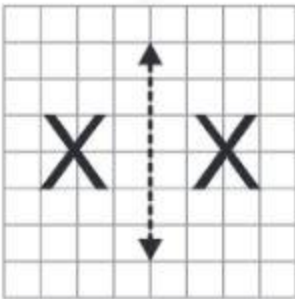
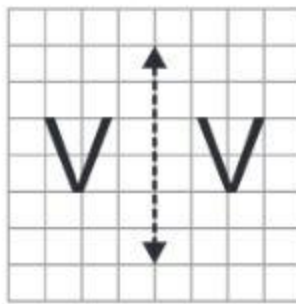
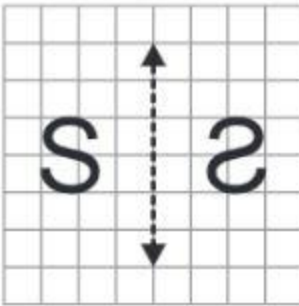
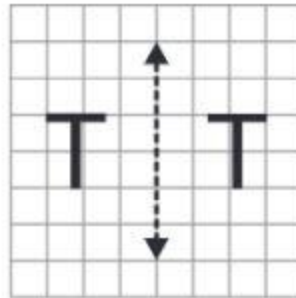
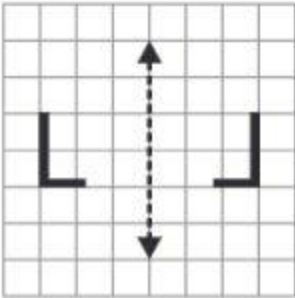
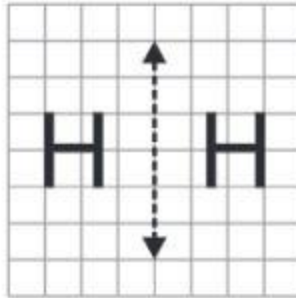
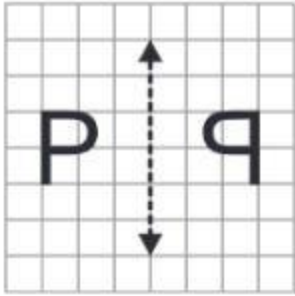

NCERT 6th Maths Chapter 13, class 6 Maths Chapter 13 solutions

<https://www.indcareer.com/schools/ncert-solutions-for-6th-class-maths-chapter-13-symmetry/>



Chapterwise NCERT Solutions for Class 6 Maths :

- Chapter 1 Knowing Our Numbers
- Chapter 2 Whole Numbers
- Chapter 3 Playing with Numbers
- Chapter 4 Basic Geometrical Ideas
- Chapter 5 Understanding Elementary Shapes
- Chapter 6 Integers
- Chapter 7 Fractions
- Chapter 8 Decimals
- Chapter 9 Data Handling
- Chapter 10 Mensuration
- Chapter 11 Algebra
- Chapter 12 Ratio and Proportion
- Chapter 13 Symmetry
- Chapter 14 Practical Geometry

<https://www.indcareer.com/schools/ncert-solutions-for-6th-class-maths-chapter-13-symmetry/>

About NCERT

The National Council of Educational Research and Training is an autonomous organization of the Government of India which was established in 1961 as a literary, scientific, and charitable Society under the Societies Registration Act. The major objectives of NCERT and its constituent units are to: undertake, promote and coordinate research in areas related to school education; prepare and publish model textbooks, supplementary material, newsletters, journals and develop educational kits, multimedia digital materials, etc. Organise pre-service and in-service training of teachers; develop and disseminate innovative educational techniques and practices; collaborate and network with state educational departments, universities, NGOs and other educational institutions; act as a clearing house for ideas and information in matters related to school education; and act as a nodal agency for achieving the goals of Universalisation of Elementary Education. In addition to research, development, training, extension, publication and dissemination activities, NCERT is an implementation agency for bilateral cultural exchange programmes with other countries in the field of school education. Its headquarters are located at Sri Aurobindo Marg in New Delhi. [Visit the Official NCERT website](#) to learn more.

<https://www.indcareer.com/schools/ncert-solutions-for-6th-class-maths-chapter-13-symmetry/>